

## ROBOT Compact HUMARD®

adapted to fit CNC machine type DMG Sauer Ultrasonic 50

### Compact – Autonomous



#### Dimensions

X: 1'270 mm







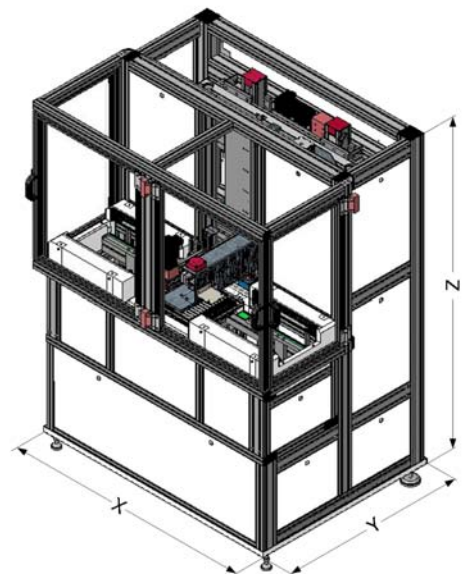

Y: 1'010 mm

Z: 1'900 mm

Surface area : 1.28 m<sup>2</sup>



#### Benefits of Compact HUMARD® ROBOT

-  Low floor space
-  Can be adapted to fit all CNC machines
-  5 axes
-  Rapid workpiece series changeover
-  Continuous operation and productivity gains
-  Telemaintenance commanded via modem
-  Ergonomic design meets EC safety standards
-  LOGIC'HUMARD® programming with touch screen

© HUMARD Automation SA / Subject to technical modifications

CE



#### **HUMARD Automation SA**

6, rue St-Randoald  
CH-2800 Delémont  
Switzerland  
Tél. +41 32 421 40 90  
Fax +41 32 423 29 26  
www.humard.com  
info@humard.com