

ROBOT Compact HUMARD®

adapted to fit CNC machine type STUDER S21

Compact – Autonomous



Dimensions

X: 1'440 mm







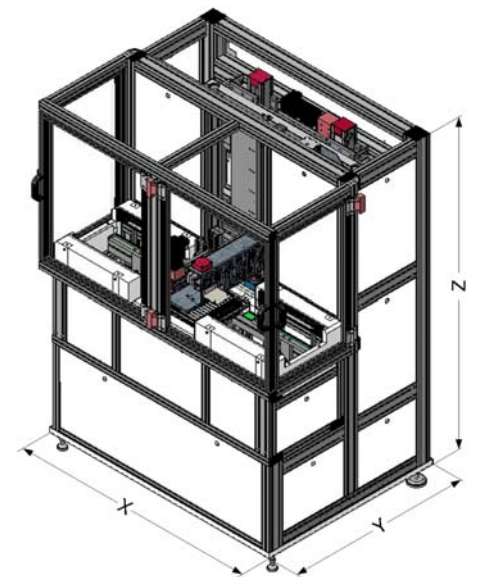

Y: 1'070 mm

Z: 1'900 mm

Surface area: 1.54 m²



Benefits of Compact HUMARD® ROBOT

-  Low floor space
-  Can be adapted to fit all CNC machines
-  5 axes
-  Rapid workpiece series changeover
-  Continuous operation and productivity gains
-  Telemaintenance commanded via modem
-  Ergonomic design meets EC safety standards
-  LOGIC'HUMARD® programming with touch screen

© HUMARD Automation SA / Subject to technical modifications

CE



HUMARD Automation SA

6, rue St-Randoald
CH - 2800 Delémont
Switzerland
Tél. +41 32 421 40 90
Fax +41 32 423 29 26
www.humard.com
info@humard.com