

ROBOT Compact HUMARD® adapté sur machine CNC type Bumotec S-191

Compact – Autonome



Dimensions

X: 1'270 mm





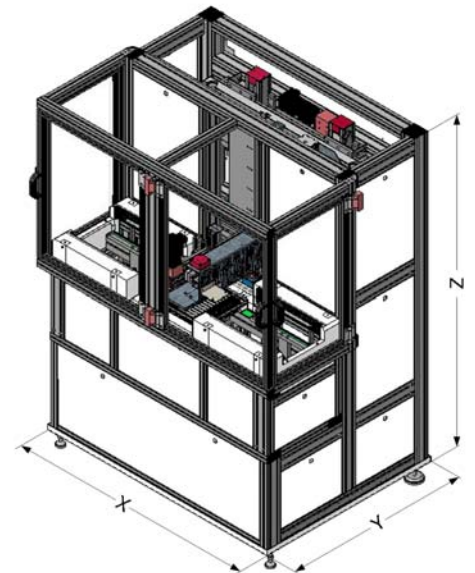

Y: 1'010 mm

Z: 1'900 mm

Surface: 1.28 m²



Les avantages du ROBOT Compact HUMARD®

-  Faible encombrement au sol (compact)
-  Adaptable sur tout type de machine CNC
-  5 axes
-  Changement rapide de série de pièces
-  Fonctionnement en continu et gain de productivité
-  Télémaintenance à distance par modem
-  Conception ergonomique répondant aux normes de sécurité CE
-  Programmation «LOGIC' *HUMARD* » avec écran tactile

© HUMARD Automation SA / Sous réserve de modifications techniques

CE



HUMARD Automation SA

6, rue St-Randoald
CH - 2800 DELEMONT
Switzerland
Tél. +41 32 421 40 90
Fax +41 32 423 29 26
www.humard.com
info@humard.com