

ROBOT Compatto HUMARD®

adatto su centro di lavoro tipo DMG Sauer Ultrasonic 50

Compatto – Autonomo



Dimensioni

X: 1'270 mm







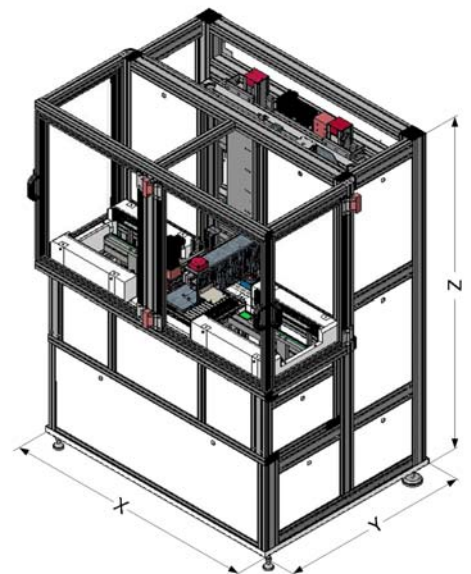

Y: 1'010 mm

Z: 1'900 mm

Superficie : 1.28 m²



I vantaggi del ROBOT Compatto HUMARD®

-  Ingombro ridotto
-  Adattabile a qualunque tipo di macchina CNC
-  5 assi
-  Cambio rapido della serie pezzi
-  Funzionamento continuo e maggior produttività
-  Telemanutenzione via modem
-  Design ergonomico conforme alle norme di sicurezza CE
-  Programmazione «LOGIC'HUMARD®», schermo tattile

© HUMARD Automation SA / Sogetto a modifiche tecniche

CE



HUMARD Automation SA

6, rue St-Randoald

CH-2800 Delémont

Switzerland

Tél. +41 32 421 40 90

Fax +41 32 423 29 26

www.humard.com

info@humard.com